

# SPECIFICATION

## 产品规格书

NO. (编号): XY-SE-PE-0000

Part No.(型号): XY-2835WX-HE-3C1B

Description(描述): 2835 LED

Version NO.(版本): A0

Date(日期): \_\_\_\_\_

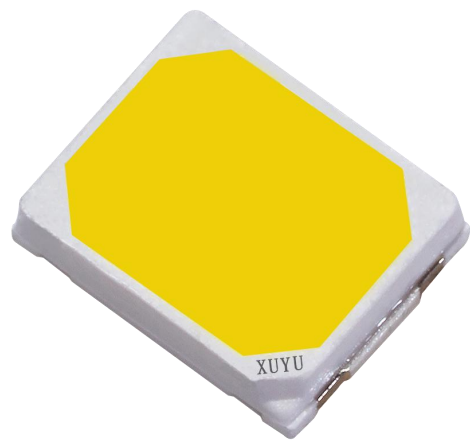

Customer Approved (客户审核)		Approved (确认)	
Xuyu Approved (旭宇审核)		Approved (确认)	Issued (制定)
卢淑芬		林伟龙	张香伟
<input type="checkbox"/> Sample (样品)		<input checked="" type="checkbox"/> Mass Product (量产供货)	



## 目录

Features 特性.....	2
Applications 产品应用.....	2
Package Dimensions 产品外观尺寸.....	3
Product coding rules 产品编码规则.....	4
Electro Optical Characteristics (TA=25°C) 光电特性.....	5
Absolute Maximum Ratings (TA=25°C) 最大额定值.....	6
Mass Production List 生产目录.....	7
Spectral Distribution 光谱分布特性曲线.....	8
Forward Voltage vs Forward Current 伏安特性曲线.....	8
Relative Luminous vs Forward Current 相对光通量与正向电流.....	9
Ambient Temperature vs Forward Current 引脚温度与正向电流.....	9
Relative Flux vs Junction Temperature 相对光通量与结温特性曲线.....	10
View Angle Distribution 空间角度分布.....	11
CIE Chromaticity Diagram: CIE 欧盟色度图.....	12
Color Rank 欧盟分 Bin 规格.....	13
CIE Chromaticity Diagram 美规 CIE 色度图.....	14
Color Rank 美规分 Bin 规格.....	15
Packaging Specifications 包装规格.....	16
Label (标签).....	17
SMT Reflow Soldering Instructions SMT 回流焊说明.....	18
CARTIONS 注意事项.....	19

## ◆ Features 特性:

- \* Small package with high efficiency 体积小，光效高
- \* Low voltage operation, Instant light 电压低，发光响应快
- \* Long operation life 工作寿命长
- \* Lead free product 不含铅，环保
- \* RoHS compliant 通过 RoHS 认证

## ◆ Applications 产品应用:

- \*Traditional lighting replacement 传统照明替换
- \*Ordinary lighting 普通照明
- \*Indoor&Outdoor sign board back light 标识牌背光
- \*Architectural / Decorative Lighting 建筑装饰照明

◆ **Package Dimensions 产品外观尺寸**

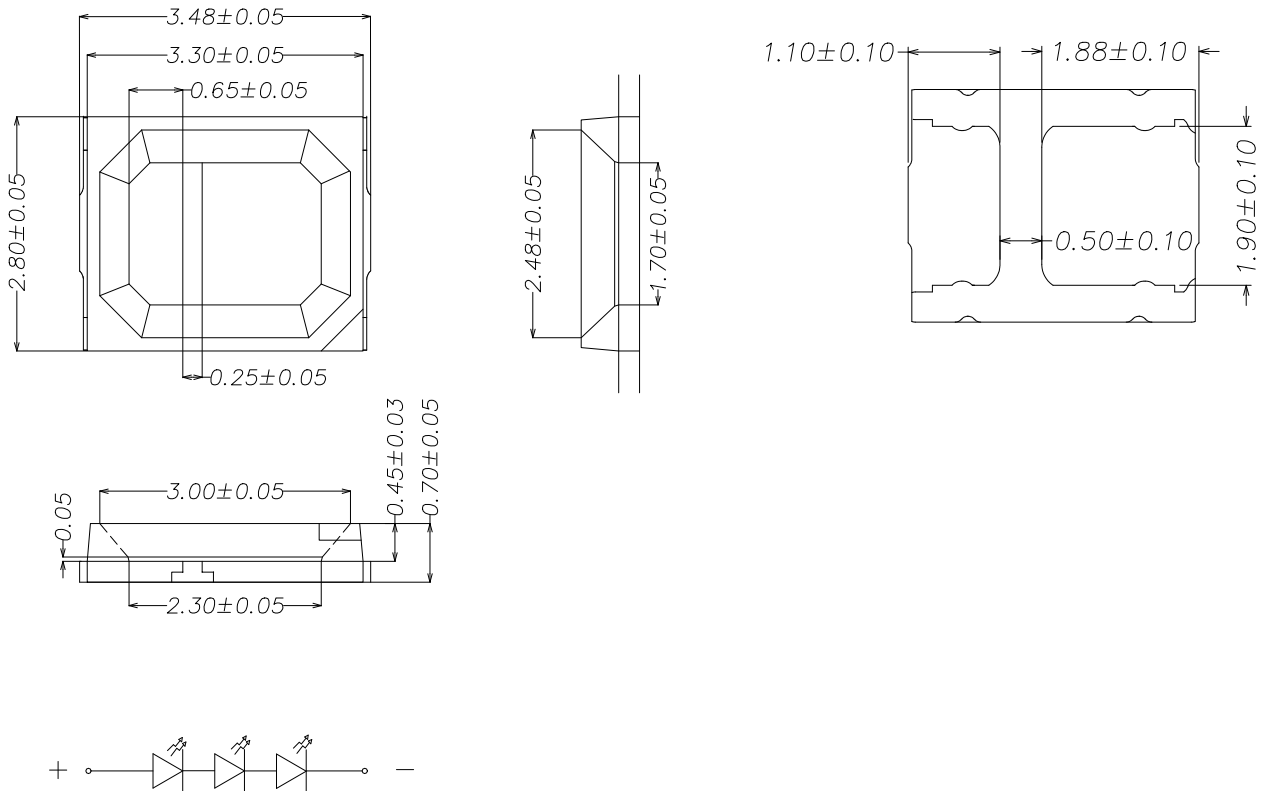

**Soldering patterns 建议焊盘图**

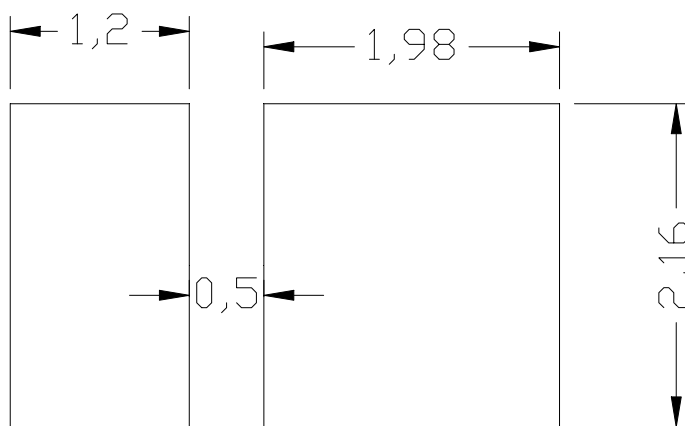

**Notes:**

1. All dimensions are in mm 所有尺寸单位为毫米。
2. Tolerance is  $\pm 0.15\text{mm}$  unless otherwise noted. 非特殊标注, 公差为 $\pm 0.15$  毫米

◆ **Product coding rules** 产品编码规则

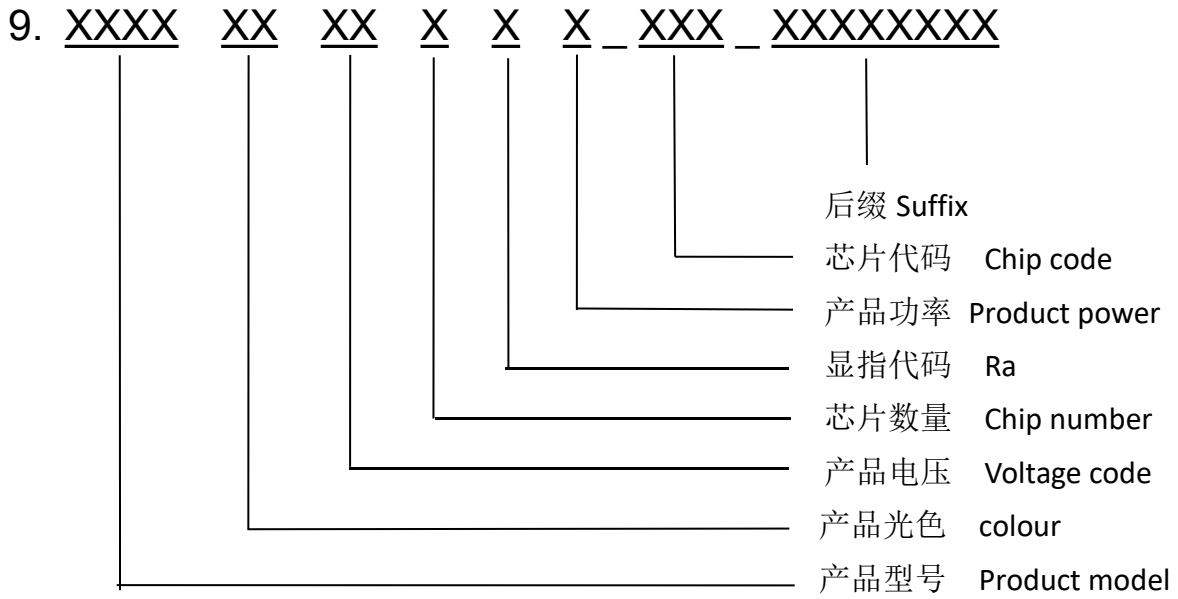

## ◆ Electro Optical Characteristics (TA=25°C) 光电特性

Parameter 参数	Test Condition 测试条件	Symbol 符号	Min 最小值	Typ 典型值	Max 最大值	Unit 单位
Forward Voltage 正向电压	$I_f=100\text{mA}$	$V_F$	8	---	10	V
View Angle 发光角度	$I_f=100\text{mA}$	2 $\theta$ 1/2	---	120	---	deg.
Electrostatic Discharge 抗静电	HBM	ESD	---	---	2000	V
Color tolerance 色容差	$I_f=100\text{mA}$	SDCM	---	---	6	---

### ◆ Absolute Maximum Ratings (T<sub>A</sub>=25°C) 最大额定值

Parameter (参数)	Symbol (符号)	Rating (等级)	Unit (单位)
Forward Current 正向电流	I <sub>F</sub>	100	mA
Pulse Forward Current 正向脉冲电流	I <sub>FP</sub>	240	mA
Power Dissipation 额定功率	P <sub>O</sub>	960	mW
Reverse voltage 反向电压	V <sub>R</sub>	15	V
Operation temperature 操作温度	T <sub>opr</sub>	-40 to +85	°C
Storage Temperature Range 储存温度范围	T <sub>stg</sub>	-40 to +85	°C
Junction Temperature 结温	T <sub>j</sub>	125	°C
Thermal resistance 热阻	R <sub>θ</sub>	13	°C/W
Soldering Temperature 回流温度	T <sub>sld</sub>	260°C for 10sec	

#### Notes:

1. Frequency 10KHz, duty ratio ≤10%      频率 10KHz ， 占空比≤10%
2. The forward pulse current is the maximum current used by the chip at 25 °C.  
正向脉冲电流为芯片在 25°C 下使用的最大电流。

**◆ Mass Production List (IF=100mA;TA=25°C) 生产目录**

Part NO.型号	Color Rendering index 显指	CCT (K) Min	CCT (K) Typ	CCT (K) Max	(lm/w) Min	(lm/w) Max
XY-2835W1-HE-3C1B	70	---	6500	---	190	210
XY-2835W1-HE-3C1B	80	---		---	175	195
XY-2835W1-HE-3C1B	90	---		---	135	155
XY-2835W1-HE-3C1B	70	---	5700	---	190	210
XY-2835W1-HE-3C1B	80	---		---	175	195
XY-2835W1-HE-3C1B	90	---		---	135	155
XY-2835W1-HE-3C1B	70	---	5000	---	190	210
XY-2835W1-HE-3C1B	80	---		---	175	195
XY-2835W1-HE-3C1B	90	---		---	135	155
XY-2835W2-HE-3C1B	70	---	4000	---	190	210
XY-2835W2-HE-3C1B	80	---		---	175	195
XY-2835W2-HE-3C1B	90	---		---	135	155
XY-2835W3-HE-3C1B	70	---	3500	---	180	200
XY-2835W3-HE-3C1B	80	---		---	165	185
XY-2835W3-HE-3C1B	90	---		---	125	145
XY-2835W3-HE-3C1B	70	---	3000	---	180	200
XY-2835W3-HE-3C1B	80	---		---	165	185
XY-2835W3-HE-3C1B	90	---		---	125	145
XY-2835W3-HE-3C1B	70	---	2700	---	170	190
XY-2835W3-HE-3C1B	80	---		---	155	175
XY-2835W3-HE-3C1B	90	---		---	115	135

**Note:** The test error 测试误差

$V_f: \pm 2\%$

$XY: \pm 0.003$

$\Phi: \pm 10\%$

$Ra: \pm 1$



◆ **Spectral Distribution 光谱分布特性曲线 Ra70**

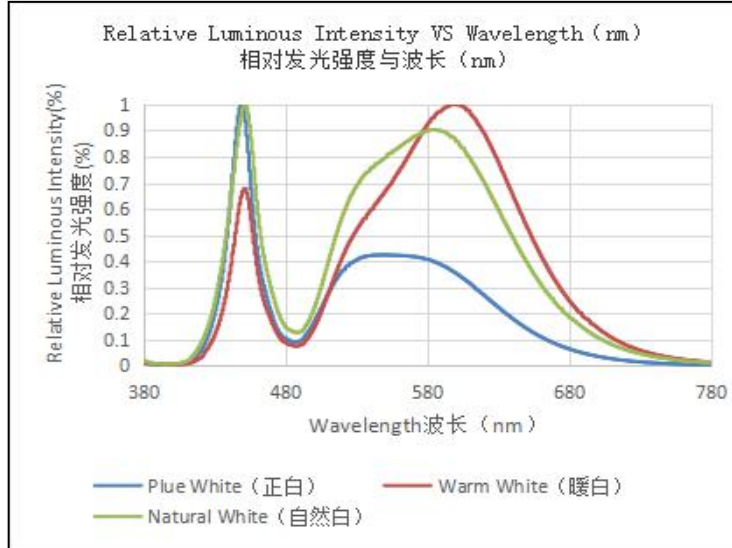

◆ **Spectral Distribution 光谱分布特性曲线 Ra80**

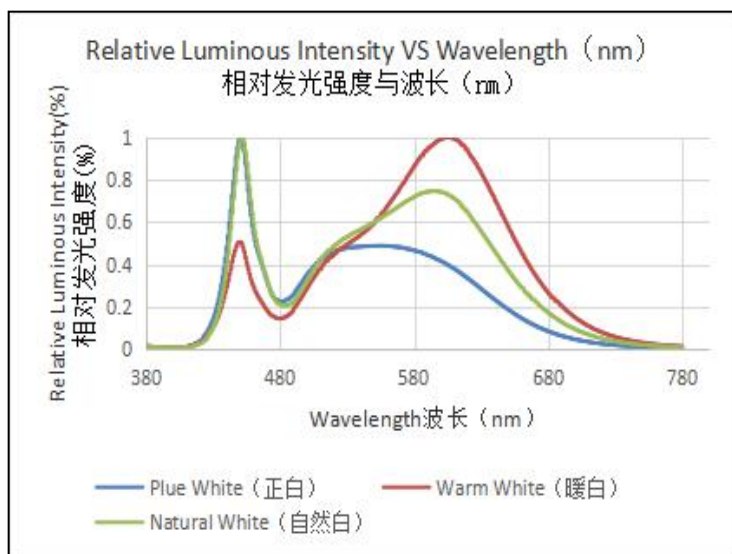

◆ **Spectral Distribution 光谱分布特性曲线 Ra90**

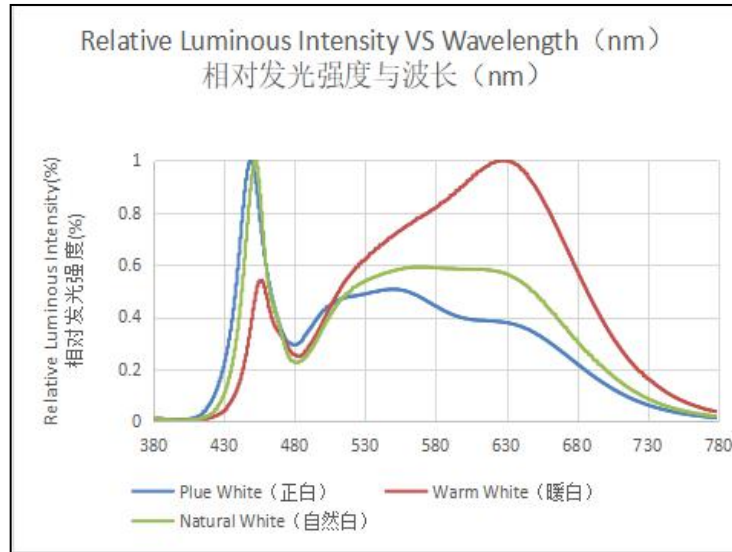

◆ **Forward Voltage vs Forward Current 伏安特性曲线**

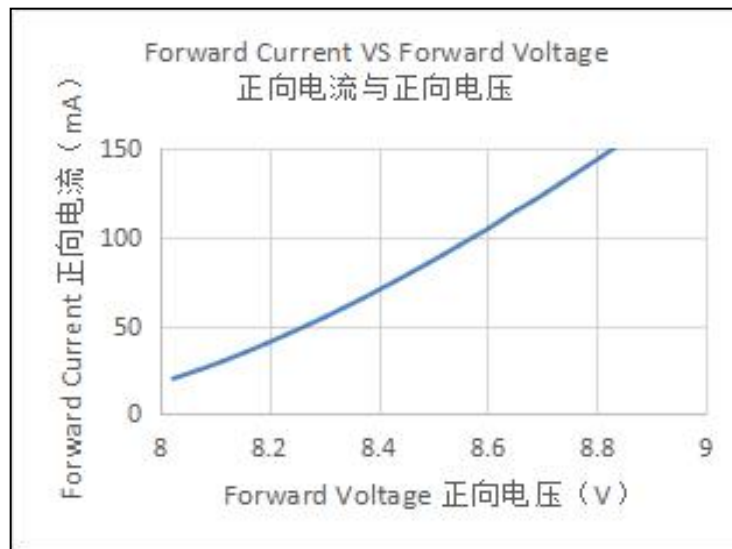

◆ **Relative Luminous vs Forward Current** 相对光通量与正向电流

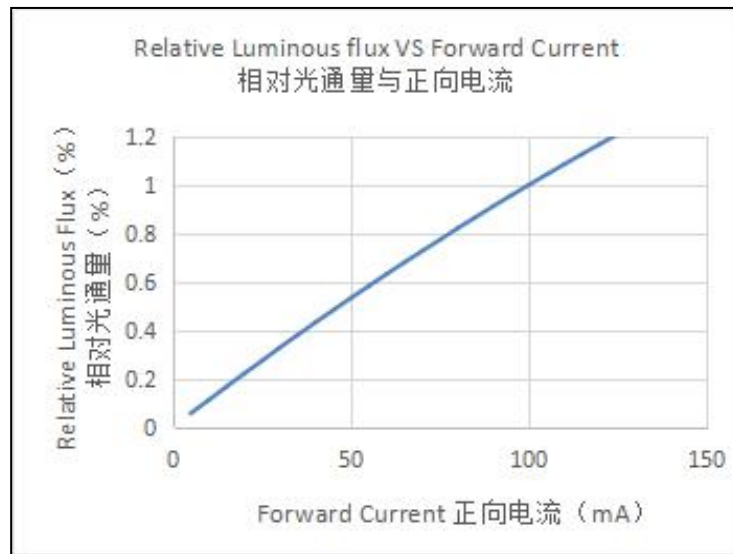

◆ **Ambient Temperature vs Forward Current** 引脚温度与正向电流

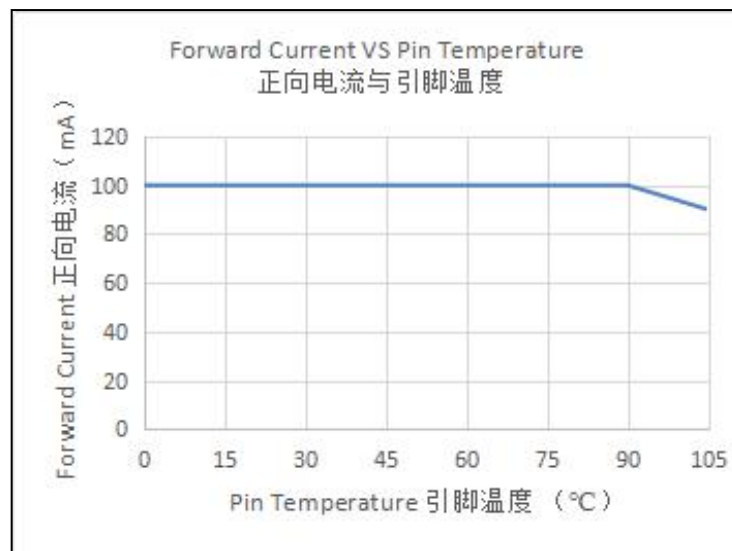

◆ **Relative Flux vs Junction Temperature** 相对光通量与结温特性曲线

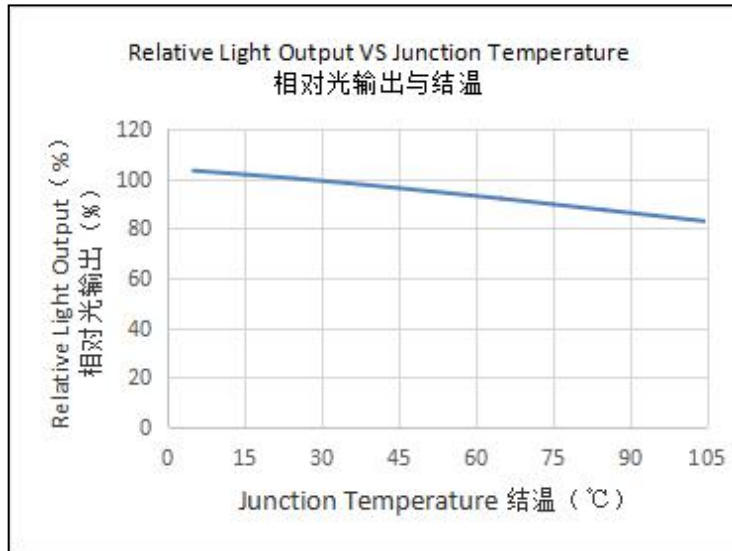

◆ **View Angle Distribution** 空间角度分布

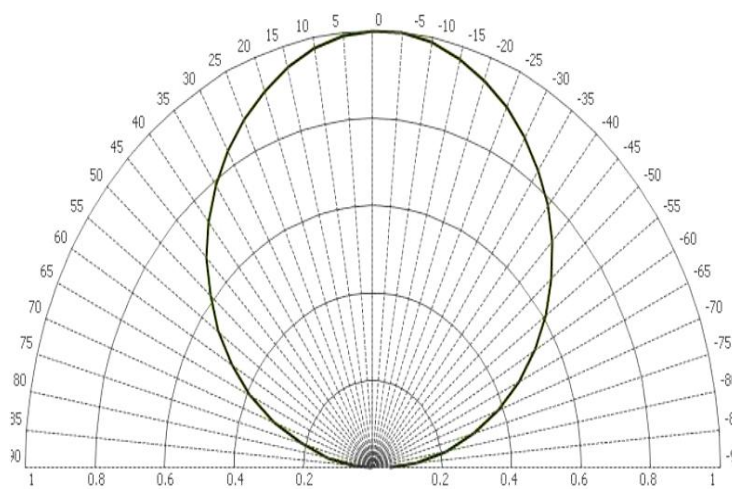

◆ CIE Chromaticity Diagram:(IF=100mA;TA=25°C) CIE 欧盟色度图

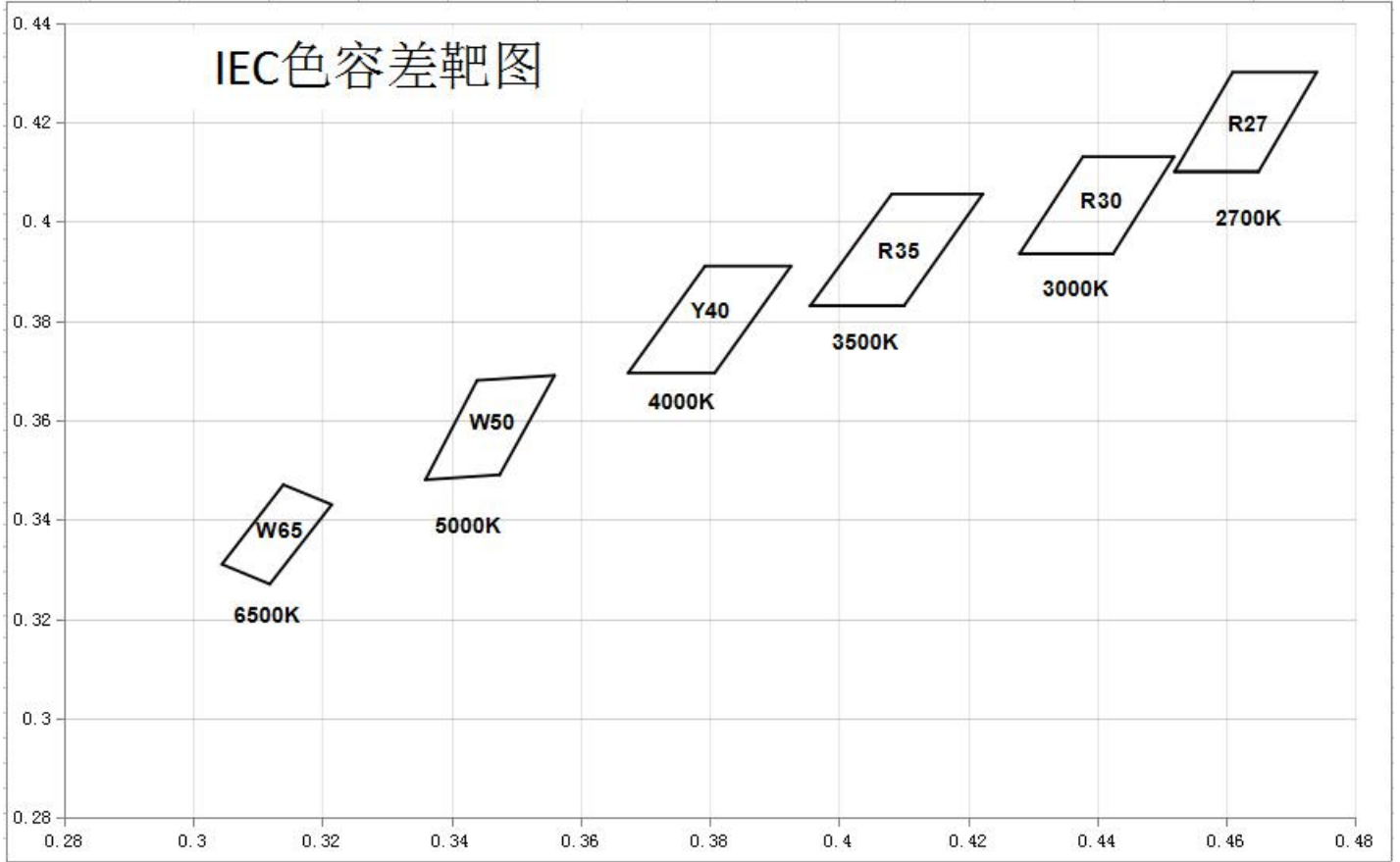

◆ **Color Rank :(IF=100mA;TA=25℃) 欧盟分 Bin 规格**

CODE	CCT	X	Y
R27	2700K	0.4616	0.4255
		0.4575	0.4165
		0.4664	0.4165
		0.4705	0.4255

CODE	CCT	X	Y
R30	3000K	0.4378	0.413
		0.428	0.3935
		0.4425	0.3935
		0.4519	0.413

CODE	CCT	X	Y
R35	3500K	0.4082	0.4055
		0.3956	0.383
		0.4101	0.383
		0.4223	0.4055

CODE	CCT	X	Y
Y40	4000K	0.3793	0.391
		0.3674	0.3695
		0.3808	0.3695
		0.3926	0.391

CODE	CCT	X	Y
W50	5000K	0.344	0.368
		0.336	0.348
		0.3475	0.349
		0.356	0.369

CODE	CCT	X	Y
W65	6500K	0.314	0.347
		0.3045	0.331
		0.3119	0.327
		0.3215	0.343

◆ CIE Chromaticity Diagram:(IF=100mA;TA=25°C)CIE 美规色度图

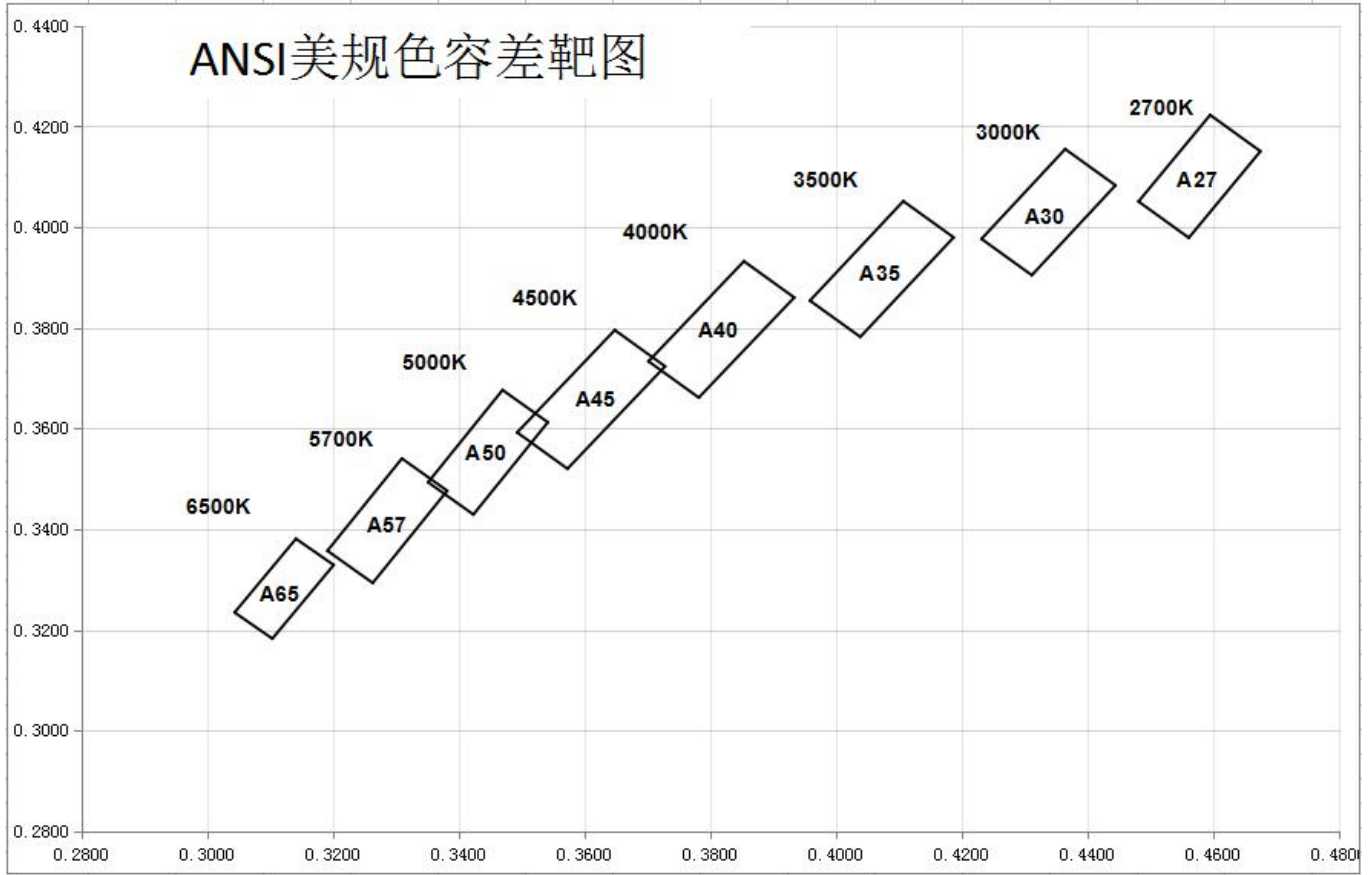

**◆ Color Rank : (IF=100mA;TA=25°C) 美规分 Bin 规格**

CODE	CCT	X	Y
A27	2700K	0.4595	0.4223
		0.4481	0.4051
		0.4561	0.3979
		0.4675	0.4151

CODE	CCT	X	Y
A30	3000K	0.4365	0.4155
		0.4231	0.3977
		0.4311	0.3905
		0.4445	0.4083

CODE	CCT	X	Y
A35	3500K	0.4107	0.4052
		0.3959	0.3854
		0.4039	0.3782
		0.4187	0.3980

CODE	CCT	X	Y
A40	4000K	0.3854	0.3932
		0.3702	0.3734
		0.3782	0.3662
		0.3934	0.3860

CODE	CCT	X	Y
A45	4500K	0.3649	0.3796
		0.3493	0.3592
		0.3573	0.3520
		0.3729	0.3724

CODE	CCT	X	Y
A50	5000K	0.3470	0.3677
		0.3352	0.3493
		0.3424	0.3429
		0.3542	0.3613

CODE	CCT	X	Y
A57	5700K	0.3310	0.3541
		0.3192	0.3357
		0.3264	0.3293
		0.3382	0.3477

CODE	CCT	X	Y
A65	6500K	0.3142	0.3381
		0.3044	0.3235
		0.3104	0.3183
		0.3202	0.3329



## ◆ Packaging Specifications 包装规格

### Dimensions of Tape 载带规格

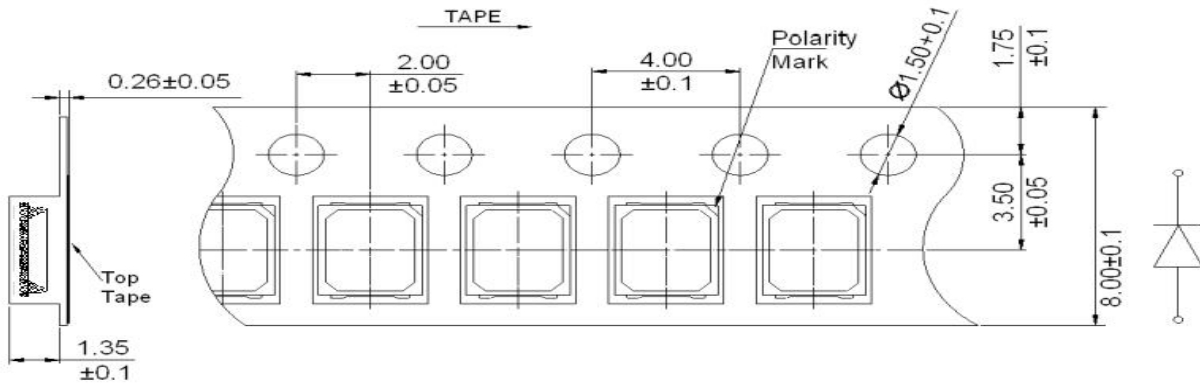

### Dimensions of Reel 卷盘规格

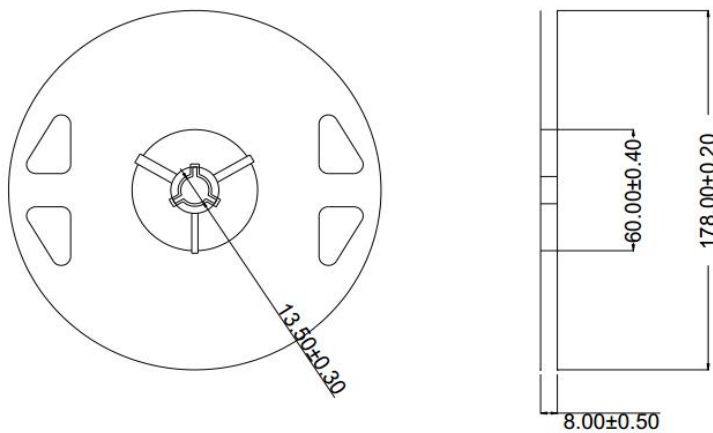

### Packaging specifications 包装规格

2835 4K/16K/盘 参考数量 具体以实际数量为准

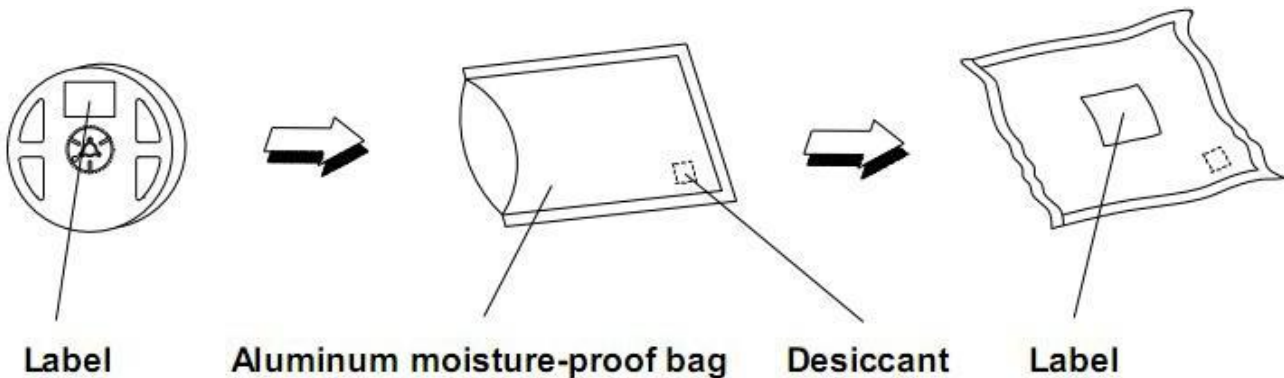

◆Label(标签):



Part NO: 产品型号 Product model

LOT NO: 指令单号 Instruction number

IV : 光通量 Luminous flux

V<sub>F</sub>/I<sub>F</sub>: 电压/电流 Voltage /Electric current

CCT/XY: 色温/色区 Color temperature / Color Coordinates

Ra/SD/R9: 显色指数/色容差/饱和红色度 Color Rendering index/Color tolerance /R9

Q'ty: 数量 Quantity

Date: 日期 Date

Code: 产品代码 Product code

## ◆ SMT Reflow Soldering Instructions SMT 回流焊说明

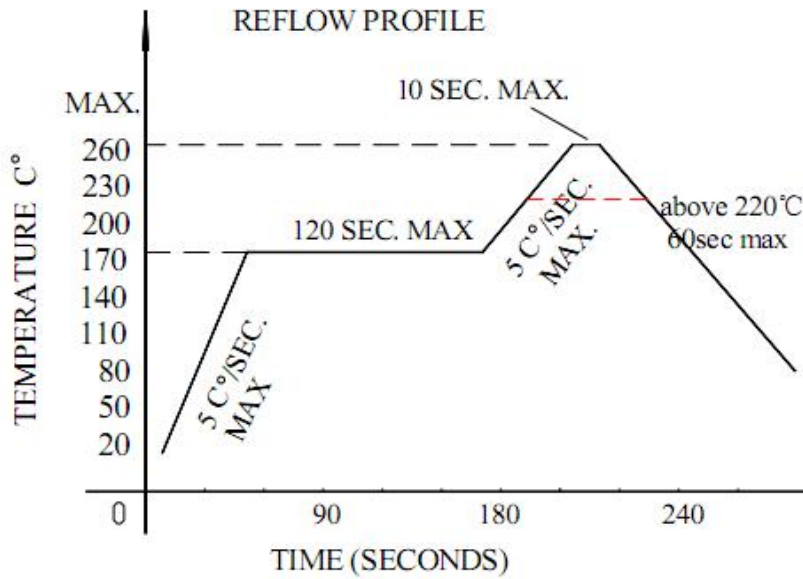

1. Reflow soldering should not be done more than two times  
回流焊不可以做两次以上
2. When soldering, do not put stress on the LEDs during heating  
当焊接时，材料受热，不可以用力按压胶体表面

## ◆ CARTIONS 注意事项

1, The encapsulated material of the LEDs is silicone. Therefore the LEDs have a soft surface on the top of package. The pressure to the top surface will be influence to the reliability of the LEDs. Precautions should be taken to avoid the strong pressure on the encapsulated part. So when use the picking up nozzle, the pressure on the silicone resin should be proper.

1、LED 封装为硅胶，故 LED 胶体表面较软，用力按压胶体表面会影响 LED 可靠性，因此应有预防措施避免在封装的零件上的强大压力，当使用吸嘴时，胶体表面的压力应是恰当的。

2, Compare to epoxy encapsulant that is hard and brittle, silicone is softer and flexible. Although its characteristic significantly reduces thermal stress, it is more prone to damage by external mechanical force . As a result, Special handling precautions must be observed during assembling using silicone encapsulated LED products, Failure to comply might leads to damage and premature failure of the LED.

①, Handle the component along the side surface by using forceps or appropriate tools; do not directly touch or Handle the silicone lens surface, it may damage the internal circuitry.

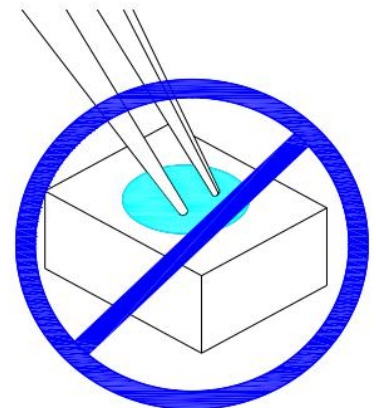
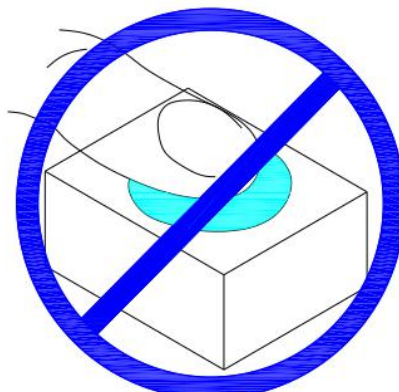
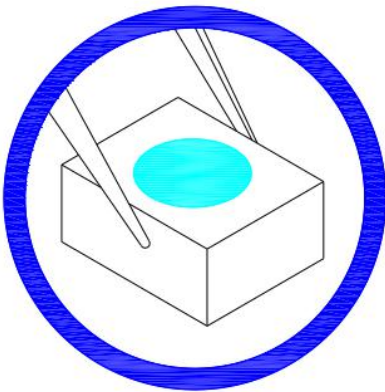

②, Do not stack together assembled PCBs containing LEDs. Impact may scratch the silicone lens or damage the internal circuitry.

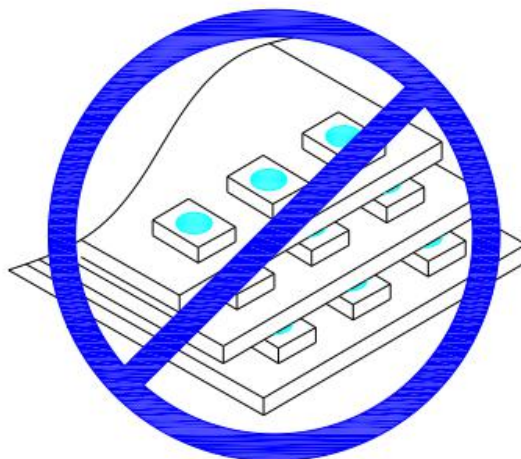

2、相对环氧树脂较脆较硬而言，硅胶封装较柔软且有弹性，虽然它的特性大大减少了热应力，但易受机械外力损坏，因此在手工处理方面须要对硅胶封装材料做预防措施，若未按要求操作，可能会导致 LED 损坏和光衰。

①，通过使用适当的工具从材料侧面夹取，不可直接用手或尖锐金属压胶体表面，它可能会损坏内部电路。

②，不可将模组材料堆积在一起，它可能会损坏内部电路。

3, Material confirmation. Whether the LED Bin specifications of the material are consistent, such as whether  $V_F$ , XY, brightness and so on belong to the same specification, the same specification should be used together, if not the same specification LED is applied to the same object, it should be evaluated first, (if different  $V_F$  or XY cast together may produce difference in brightness or color).

3、物料确认。投料的 LED Bin 规格是否一致，如  $V_F$ 、XY、亮度等是否属同一规格，同一规格的应在一起使用，若不是同一规格的 LED 应用在同一物件上，应先评估其适用性，（若不同  $V_F$  或 XY 投在一起可能会发生亮度上或颜色上的差异）。

#### 4, Packaging and storage。

4.1 Before opening packaging, avoid moisture entry into LED. SMD series LED is suggested to be stored in a drying cabinet with built-in desiccant. The storage environment is 5-30 centigrade, no more than 50% humidity. If storage time is over 3 months, LED needs to be re dehumidifying (65 degrees centigrade for more than /24 hours).

4.2 Open the precautions after packing. LED is a surface mount. When the LED is welded, the internal separation of LED may occur. The luminescence efficiency is affected and the luminance decreases or the color variation. The following are the matters to be paid attention to:

A, Before opening the package, please check the packaging bag for air leakage. If there is any air leakage, please return it to our company to re-bake the dehumidifying package before use.

B, After opening the package, welding should be completed as soon as possible (within 12 hours).

C, The remaining materials are sealed or placed in an environment of 5~40 C and no more than 30% humidity.

D, If the open package is more than 24 hours (< 168 hours) or the humidity card is changed from blue to pink, LED needs to be dehumidifying again (65 degrees centigrade for more than /24 hours). If the package is opened for more than 168 hours, it is necessary to dismantle the tape and remove the moisture at 150°C /2h.

4.3, LED electrode and bracket are made of silver plated copper alloy. The silver layer on the surface

is easy to be affected by corrosive gases. Please avoid contacting with corrosive environment to cause LED discoloration, so as to avoid the poor weldability of LED and influence the photoelectric performance. Avoid sudden changes in temperature and humidity of the environment, especially under high humidity environment, easy to produce water vapor condensation.

#### 4、包装储存。

4.1 开包装前避免湿气进入 LED 内部，建议 SMD 系列 LED 存放在内置干燥剂的干燥柜中，储存环境为温度 5-30℃，湿度不超过 50%，若存储时间超过 3 个月，LED 需要重新除潮（65℃/24 小时以上）。

4.2 打开包装后的预防措施。LED 是表面贴装件，当 LED 进行焊接时，可能会发生 LED 内部分离，其发光效率受到影响而导致亮度下降或发光颜色变异。以下是需注意的事项：

A、在开包装之前，请先检查包装袋有无漏气，如果有漏气现象，请退回我司重新烘烤除湿包装后再使用。

B、打开包装后应尽快完成焊接（12 小时内）。

C、余料请密封或放置在 5~40℃、湿度不超过 30%的环境中。

D、如果开包装超过 24 小时（<168 小时）或湿度卡由蓝色变为粉红色，LED 需要重新除潮（65℃/24 小时以上），如果开包装超过 168 小时，需要拆开卷带，除潮 150℃/2h。

4.3 LED 电极和支架是由镀银的铜合金组成，外表银层易受到腐蚀性的气体影响，请避免接触腐蚀的环境造成 LED 变色，以免产生 LED 的焊接性变差或者影响光电性能。请避免环境温湿度的骤变，尤其是高湿环境下易产生水汽凝结。

5, Electrostatic protection. LED is a chip sensitive electronic component. Various measures should be taken to avoid static electricity, such as wearing an electrostatic bracelet or anti-static gloves during use. All devices, equipment and instruments should be well grounded.

5、静电防护。LED 是晶片敏感电子元器件，应采取各种措施避免静电，诸如在使用过程中戴静电手环或防静电手套。所有的装置、设备仪器应良好接地。

6, The bracket of this product is made of PCT, which is easy to break when bent. It is not suitable for lamps such as flexible light panels.

6, 本产品支架为 PCT 材质，折弯易断裂，不适用于软灯板之类的灯具。